

OLIVIO | FLORACION

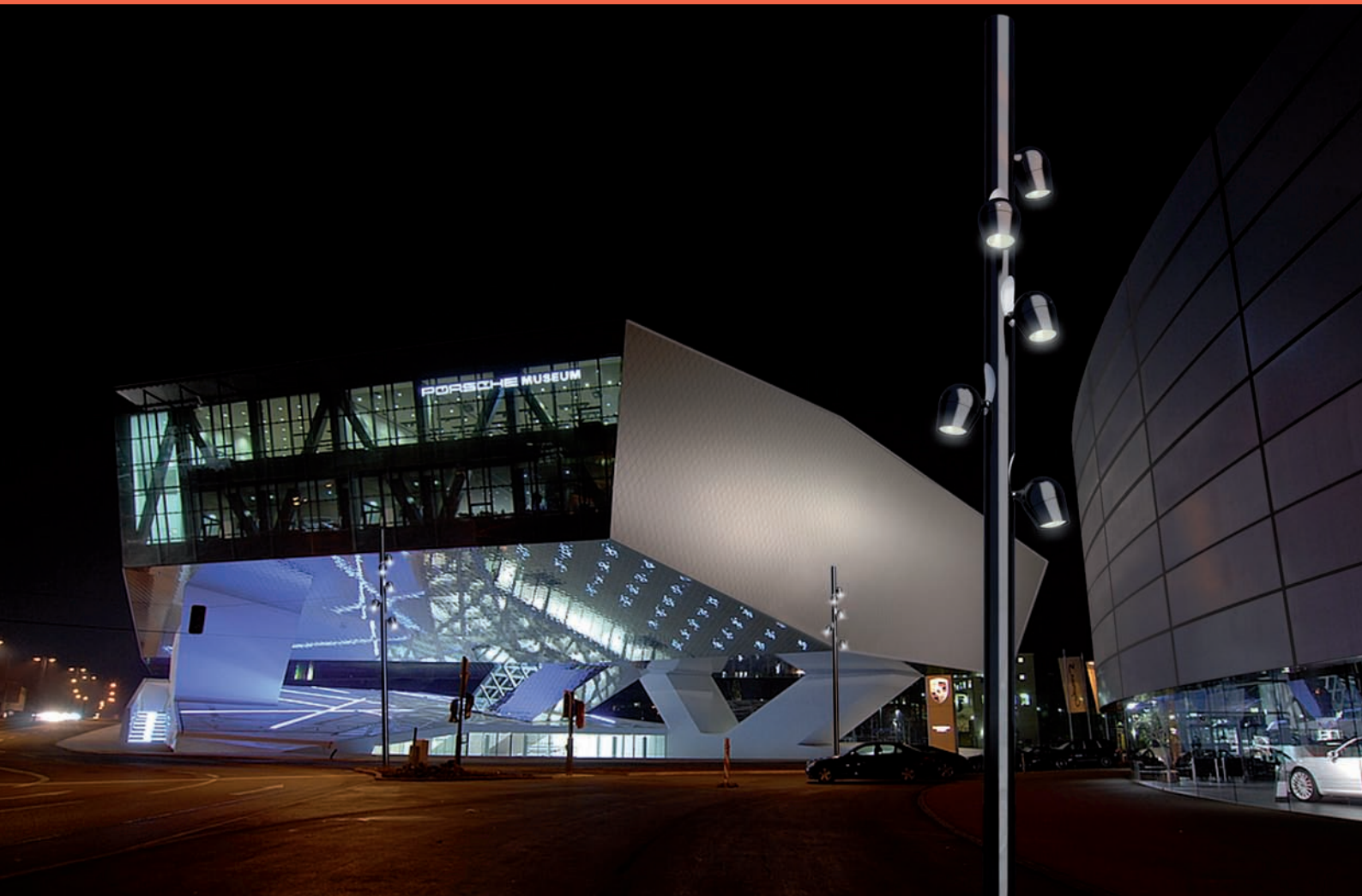

A lighting system
to define urban spaces

- DISTINCTIVE ENTRANCE AREAS
- PUBLIC PARKS
- SQUARES
- PEDESTRIAN PRECINCTS



OLIVIO FLORACION Grande
 Lateral mounted fitting with rotation adjustable beam angle at system pole. Housing made of high pressure die-cast aluminium, powder-coated, stainless steel, toughened safety glass, stainless steel screws, features easy maintenance access by looking-bar mechanism, integrated and concealed cable route through head joint, two-way adjustable head joint ensures accurately positioned light, range of head tilt at pole-inlay from 0° to 75°, choice of various optics, ingress protection rating IP67, protection class I with option class II, with joint made of high pressure die-cast aluminium, painted, pre-wired with

3x1,5mm², for attachment to custom configured FLORACION poles, standard colour: gloss black [-2].

OLIVIO Grande SX 815 ■ ■ ■ - ■
 Projector with knuckle joint

Ø: 275mm, H: 320mm, A_w: 0,079 m²
 weight: 10 kg

**Reflector/
 optical system**

 Tilt max. 5°
 Mini-Road
asymmetrical

 Tilt max. 5°
 Mini-Road
symmetrical

 Spot

 Medium

 Flood

**HIT-CE*
 OLIVIO Grande**

35W → 4 1		
LVK → 7261		
70W → 4 2		
LVK → 7261		

35W → 5 1		
LVK → 7260		
70W → 5 2		
LVK → 7260		

35W → 1 1		
LVK → 7262		
70W → 1 2		
LVK → 7262		
100W → 1 3		
LVK → 7262		

35W → 2 1		
LVK → 7263		
70W → 2 2		
LVK → 7263		
100W → 2 3		
LVK → 7263		

35W → 3 1		
LVK → 7264		
70W → 3 2		
LVK → 7264		
100W → 3 3		
LVK → 7264		

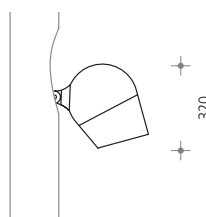
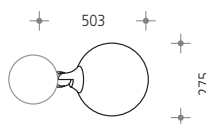

*G12 base

Mini Road reflectors were developed for horizontal illumination of roads and places. For accent lighting customers may select from spot, medium or flood reflectors.

Accessories:

Prismatic lens
SX 97-259-0

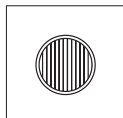

Honeycomb lens
SX 97-254-2

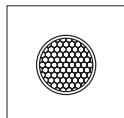

Ring louvre
SX 97-257-2

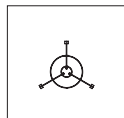

Colour filter
SX 97-...-0

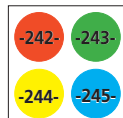

CCTV



Sound system



The housing of OLIVIO Grande provides the opportunity to incorporate technologies like CCTV or sound system on request.



ACCENT LIGHTING → **OLIVIO FLORACION** → STANDARD SYSTEM POLE

Combination of OLIVIO Grande fittings and standard system pole with pole cavity in a contrasting colour, preconfigured for three or five fittings. Depending on lighting application a range of optical systems and accessories are available. Carefully designed and engineered, OLIVIO FLORACION will enhance special locations in urban areas.

Please create a product reference number using the respective codes for light fittings, optics, pole height and pole colour as per example below. You can then specify the individual configuration of your fixture using the separate configuration sheet.

Specification example : Fitting with standard system pole 7000mm

OLIVIO Grande 5 * SX 815	Flood, HIT-CE 35W 3 1	black - 2
Pole	1 * SX 161 34 H: 7000/200mm	- 2
Buried base	1 * SX 97-053-0 H: 1000mm	- 0

Colour code: → Pole and fitting - gloss black (RAL 9004), pole inlay - gloss white (RAL 9001) → - 2

SX 161 31-2
0° ±120°

SX 161 32-2
0° ±80°

SX 161 33-2
0° ±72° ±144°

SX 161 34-2
0° ±85° ±170°

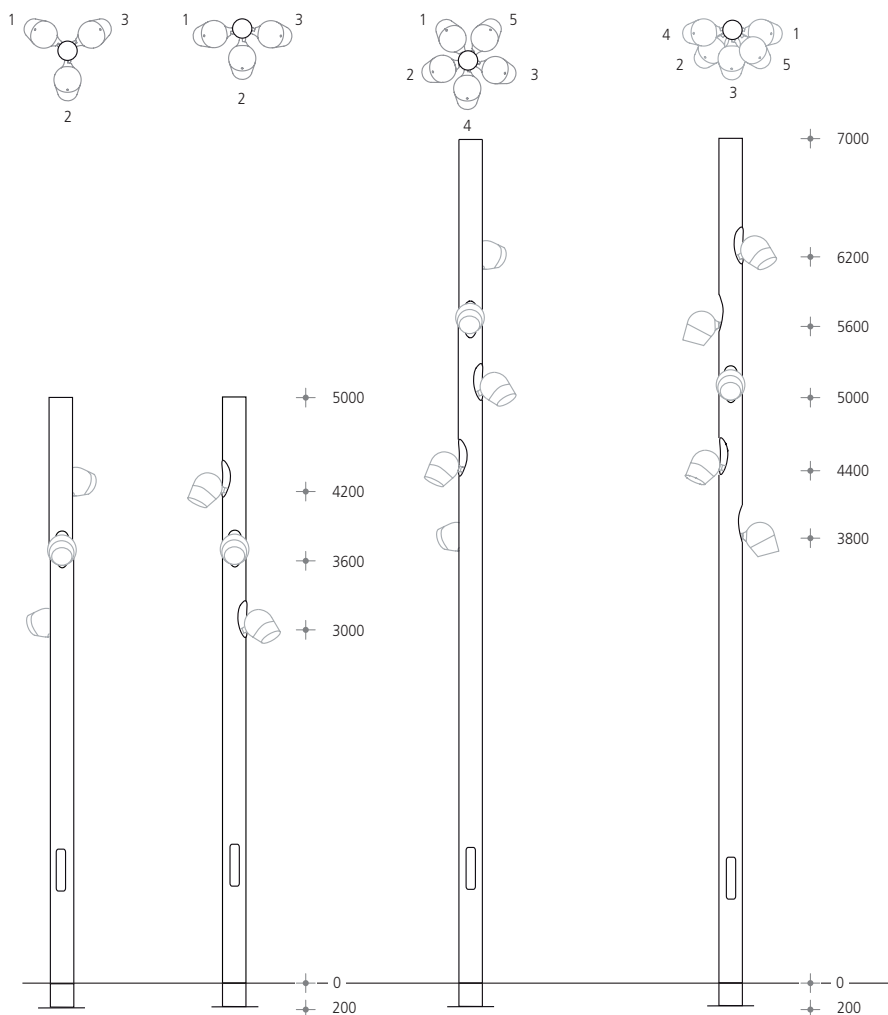

OLIVIO FLORACION - standard system pole

cylindrical galvanised steel pole Ø: 219mm, with flange plate 350mm, fixation points 240mm, for 4 x M24 stainless steel anchor bolts supplied by others, respectively separate galvanised steel buried base, pole / inlay bicolour painted, custom configured, accepts OLIVIO FLORACION lateral mounted fittings, CE-approval according to EEC standards, supplied with IP54 fuse box 2x5x16mm² for loop in-and-out.

H: 5000 / 200mm	triple full-radial	SX 161 31- 2
H: 5000 / 200mm	triple semi-radial	SX 161 32- 2
H: 7000 / 200mm	quintuple full-radial	SX 161 33- 2
H: 7000 / 200mm	quintuple semi-radial	SX 161 34- 2

Other heights on request.

Buried base of galvanised steel H: 1000mm, with flange and anti-sink plate 450mm **SX 97-053- 0**



selux offer a comprehensive range of **high-quality interior** and **exterior luminaires**. With our **innovative** products we support **architects** and **planners** in the creative design of **living** and **working spaces**. Please contact us for more information about our complete product range.

se
lux.
de



For **OLIVIO** photos, drawings, 3D-data, photometric data and catalogues please phone: **+49 (0) 30 7 20 01 - 246**, fax: **- 452**, email: team-olivio@selux.de or visit our website: www.selux.de

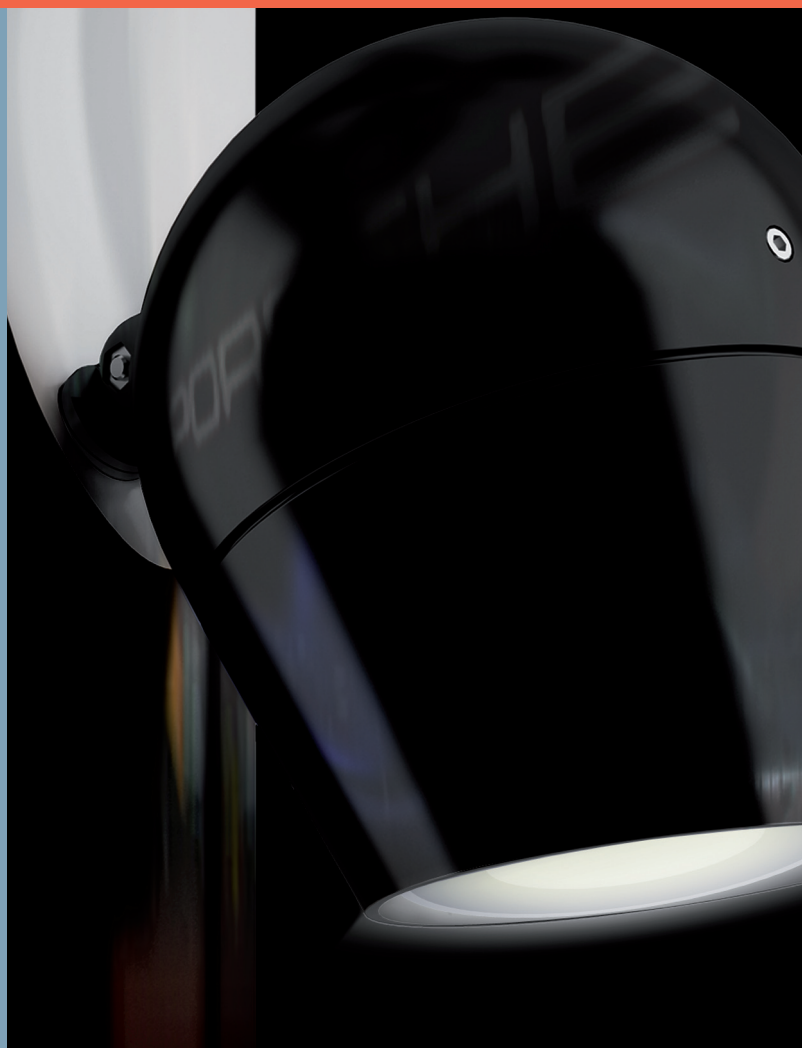
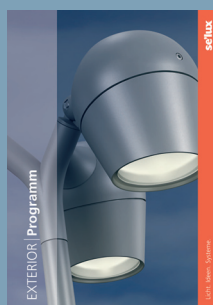

se'lux

Light. Ideas. Systems.

Semperlux Aktiengesellschaft
- Lichttechnische Werke -

Motzener Straße 34
D-12277 Berlin
Tel.: +49.30.720 01-0
Fax: +49.30.720 01-100
Email: info@selux.de
www.selux.de